

Extend | Switch | **Matrix** | Remote | Secure

Matrix

High Performance
IP KVM



What is KVM?

KVM (keyboard, video, mouse) switch technology was first introduced to the market in the 1990's as a method of controlling multiple computers with a single keyboard, video and mouse. A few years later, KVM extenders were introduced to enable the move of critical computing hardware away from the user environment and into a secure server room. The principles of KVM remain unchanged to this day, but with customers seeking ever increasing flexibility, Adder has led the way in the development of KVM matrix solutions that connect many users to many computers.

What is a KVM Matrix?

Used in many different applications, KVM matrix solutions enhance productivity, improve desktop ergonomics and reinforce security whilst providing cost savings for the business. As an alternative to siloed KVM switches, a matrix connects all users and computers to a single system where connectivity options are endless.

A KVM matrix combines the functionality of KVM switches and extenders but also adds the ability to share control and manage user access rights. Using a combination of transmitters, receivers and flexible switching architecture, systems can be built to match almost any user requirement.



Trusted by many of the world's leading organizations, Adder's range of KVM matrix solutions include both **direct-connect and IP-based options.**

The development of IP KVM matrix systems has provided new levels of scalability, flexibility and reliability that are essential in mission-critical and high-output environments such as command and control centers, broadcast and media hubs and energy and utility plants to name but a few.

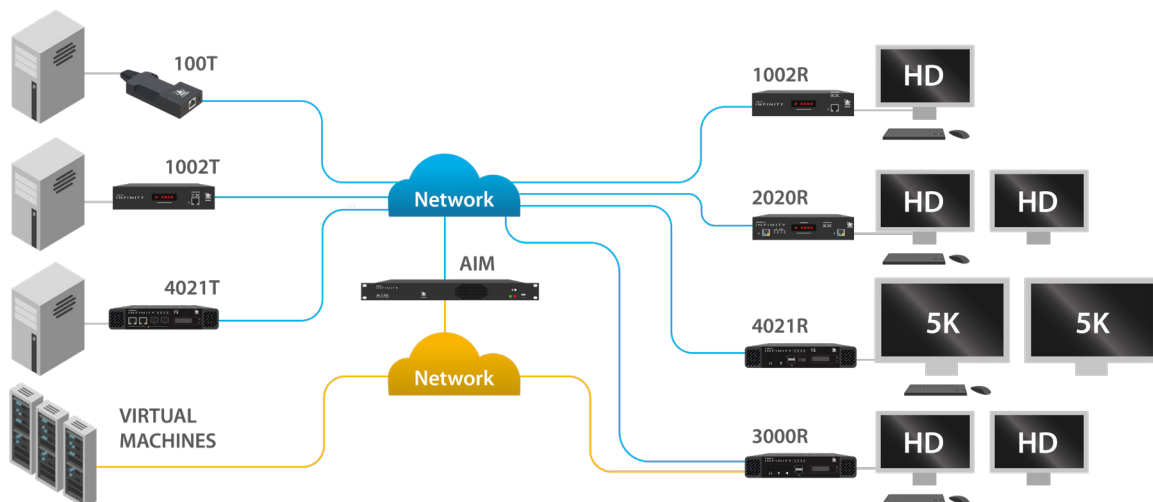

Figure 1. A typical ADDERLink INFINITY Matrix

IP versus Direct-Connect KVM

Direct-connect solutions are extremely popular and offer a great combination of features, function and reliability. However, they often lack the key functions and flexibility required by customers in a fast-paced world where change is inevitable. IP-based solutions provide significantly more flexibility at a lower total cost of ownership. With over 10 years of experience in the design and development of IP KVM solutions, Adder's products offer world-class levels of performance, resilience and security.

Reasons to Choose IP

- ✓ Build a matrix of any size and scale.
- ✓ Connect multiple rooms, buildings and campuses in the same location or across the globe.
- ✓ Grow a matrix in line with business needs.
- ✓ Distribute and access lossless video at HD to 4K, and beyond, with one protocol.
- ✓ Avoid limiting tie-lines and bottlenecks associated with direct-connect.
- ✓ Control costs - no requirement for expensive cards and chassis.
- ✓ Ensure high reliability and utilize secure network protocols.
- ✓ Provision an automated network failover for 24/7 operation.
- ✓ Utilize commoditized network hardware and their support contracts.

The ADDERLink™ INFINITY Range

The constant evolution of the workplace has seen a rising demand for results to be delivered at a faster pace than ever before. The ability to share ideas, communicate and collaborate quickly and efficiently has never been more important. With the ADDERLink INFINITY Range, businesses can:

- Increase efficiency of staff.
- Access many different computers from one screen.
- Connect between rooms, building or cities.
- Achieve real-time, at-the-PC experience for users.
- Give ergonomic, secure and flexible access to computers.
- Benefit from a world leading solution with thousands of installations.



Why Choose an Adder IP KVM Matrix?



Video Performance

ADDERLink INFINITY products are equipped with a proprietary video codec suite developed specifically for KVM applications. It delivers pixel-perfect, spatially lossless and ultra-low latency video – ensuring the video received at the desktop is identical to the digital video leaving the source. Now available up to 5K, the ADDERLink INFINITY range allows users to maximize the user experience in real-time video intensive applications.



Instant Switching

The method and speed of switching can greatly impact a KVM user's experience, reaction times and concentration levels. Adder's solutions combine instantaneous switching with real-time keyboard and mouse operation. Adder's matrix products use a combination of hotkeys, are touch screen compatible and bring up an intuitive on-screen display – ensuring a seamless user experience.



Ultimate Resilience

All complex IT systems have single points of failure which, if triggered, can interrupt the operation of infrastructure and have serious impact on the business. The ADDERLink INFINITY range offers multiple options to minimize those risks to ensure that data availability and power are constantly maintained.

They include;

- Management clusters
- Dual networking
- Resilient power management



Easy Network Configuration

Adder's IP KVM matrix solutions make use of standard IP protocols such as DHCP, IGMP and STP to ensure maximum compatibility with many different network vendors.

Many customers choose to utilize their existing IP technology in order to achieve massive cost-savings and continue to work with their preferred network vendor. However, others prefer to deploy dedicated network switches that only host their KVM system. In both scenarios, customers can be confident in the knowledge that they are using a familiar technology which is supported by their in-house staff, whilst also being able to rely on existing service level agreements with their chosen network vendor.



USB Device Compatibility

Adder's matrix solution supports a wide range of peripherals through a combination of patented USB True Emulation and transparent USB 2.0 high speed technologies. The compatibility of the ADDERLink INFINITY range makes it the ideal solution for organizations looking to support high-end colour grading tools, web cams, touch screens and many other third-party USB devices.



System Management

The ADDERLink INFINITY Manager (AIM) is a powerful and comprehensive management suite that enables users to centrally coordinate and manage all ADDERLink INFINITY devices, configure user access rights, and gain a real-time overview of connections and users. With the integration of third-party control systems via the API, AIM separates the ADDERLink INFINITY range from a traditional approach.



Security

KVM matrix solutions improve both physical and cyber security across the organization. By moving critical computing resources to a secure server room, and limiting access to dedicated personnel, organizations can mitigate the physical risk of security breach. Within the system, proven security measures restrict and log access through layers of identification, user profiles and permissions whilst the ADDERLink INFINITY platform utilizes all universal security standards to prevent data security breaches.



No Additional Software or Drivers

Many companies, particularly those operating in critical industries, have strict policies in place that limit additional software and driver installation on the user's console. Before new software can be approved for installation, it must go through rigorous testing and verification which can be both timely and costly. Adder KVM matrix solutions do not require any drivers or additional software to be installed on the PC, therefore avoiding lengthy processes and ensuring the application is functioning as quickly and securely as possible.



ADDERLink INFINITY as a Point-to-Point Extender

ADDERLink INFINITY allows USB, video and audio signals to be extended across a 1Gb network. A single transmitter and receiver pair can be connected as a point-to-point solution or over a LAN with no distance limitation.



Distances: CATx = up to 100m, Fibre = up to 10km, Network = Unlimited

ADDERLink INFINITY as a Matrix

Adding multiple transmitters, multiple receivers and an ADDERLink INFINITY Manager to a network creates a KVM matrix.

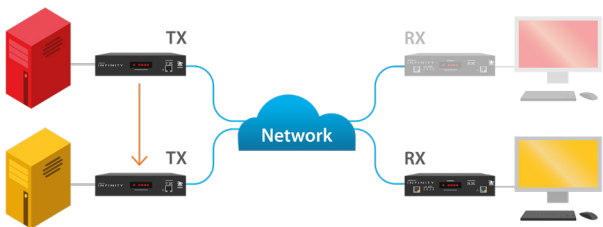

Switching Between Multiple Computers

Once they have logged in, users are presented with a simple on-screen display which they can use to switch instantly between any computers they have access to. Users can also program favourites and hotkeys to simplify the human-machine interface even further.

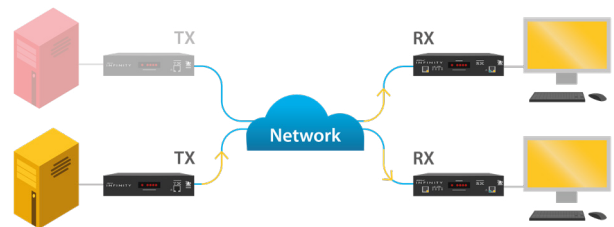



Shared Connections

A computer connection can be multicast to multiple KVM receivers to allow users to maximize collaboration and improve teamwork. All users see everything in real-time and USB control is managed by a hierarchy of access modes.

 **'Video-Only' mode:** a user can view the source (without USB control) and others can join.

 **'Shared' mode:** the user can interact with the source and others can join in Share.

 **'Exclusive' mode:** the user has full control of the source whilst others can join in view only mode.

 **'Private' mode:** the user's connection to the source remains private.

Building an Adder IP KVM Matrix

Designing an Adder IP KVM matrix could not be easier. Organizations are no longer tied to the limitations of a single switch and can instead create networks to meet their operational needs, and fit with the physical layout of their building or campus.

In addition, the ADDERLink INFINITY range has been designed to deliver a resilient architecture that prevents downtime even in the event of a rare network failure - making it the ideal solution for 24/7 operations.

Below are examples that demonstrate the flexibility that IP networks can offer.

Extended Network Design

Fiber KVM extenders are often selected when users are located a long distance away from their computers. Using standard IP networks, KVM can be used to connect users with vital resources across campuses or between cities. Networks using fiber cabling can transport multiple KVM streams on a single cable; drastically reducing the cabling infrastructure required.

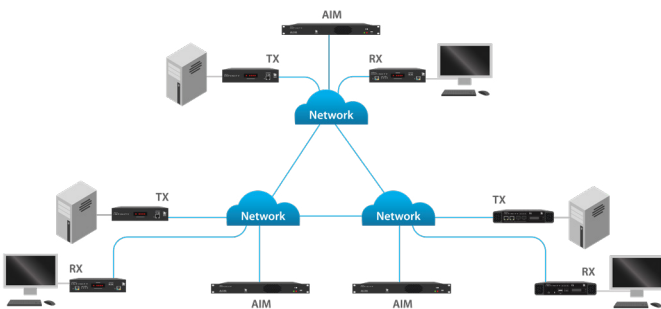
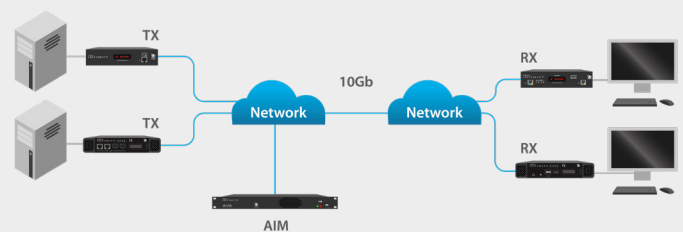

Multi-Subnet Network

The scale of larger facilities often demands long cable runs and large central matrix switches. By using IP, network hardware can be deployed for each department, or floor, as necessary. When designed well, a mix of copper and fiber cabling makes installation flexible and cost-effective. Any user can still access any source without limitation.

Resilient Network Design

A KVM matrix is often used by organizations that operate 24/7 and sometimes manage mission-critical applications. In these scenarios, resiliency and reliability are paramount. An ADDERLink™ INFINITY matrix can be built with full network redundancy, so data is load balanced across two independent networks. In the unlikely event of a network failure, an automated and instantaneous failover will keep users in control of their resources and avoid disruption to the service or transmission.

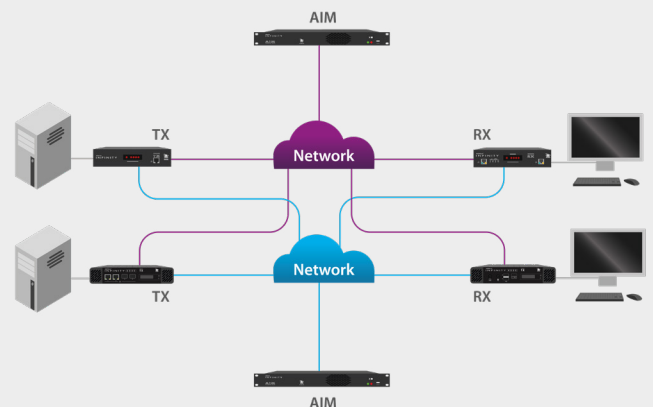

Ultimate Control with AIM

Device Management and Configuration

AIM is designed to promote the most efficient use of ADDERLink INFINITY units by allowing central control over any number of transmitters and receivers. Using the intuitive AIM web-based interface, administrators can manage thousands of users and devices from a centralized portal.

Integration with Third Party Control Systems

A matrix can be integrated with third party control systems (including Lawo, Axon, Black Magic, Crestron or AMX) to improve operational efficiency, user experience and ergonomics.

Secure User Access Rights

Using the in-built user management function, or integration with LDAP/Active Directory, organizations can control and define levels of user access.



Resiliency and Redundancy

The ADDERLink INFINITY has been designed with 24/7 mission-critical applications in mind.

- AIM is supplied on an industrialized appliance.
- AIM enables users to monitor systems using standard tools such as SNMP and Syslog.
- Multiple AIM servers guarantee management availability even in the event of an appliance failure or network disconnect.
- Full audit trail of user connections and device events.

Configure Devices for Maximum Performance

AIM gives full control of the IP settings, video performance and USB compatibility of every KVM device in the network. It can also be used to manage firmware upgrades for all transmitters and receivers.

Flexible Workflows

AIM allows users to create channels and presets that consist of multiple video, USB and audio streams to improve the efficiency of their workflows.

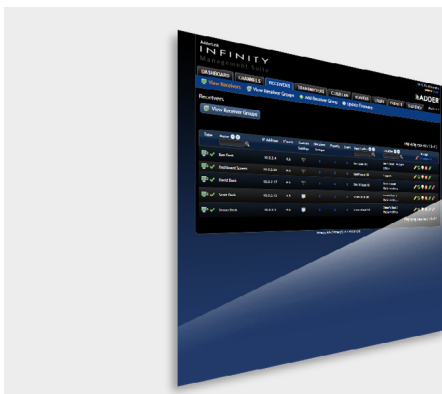

The ADDERLink INFINITY Manager User Interface



ADDERView DDX 10/30

A flexible KVM switch that provides lossless KVM extension technology with flexi-port switching ability - giving multiple users access to multiple computers.



ADDERLink XDIP

A flexible and scalable IP KVM matrix and point-to-point extender with secure remote control functionality, multi-casting capability and support for power over Ethernet (PoE).



ADDERLink INFINITY 1000/2000

An IP KVM matrix solution that allows access to multiple computers located in separate rooms, buildings or cities; making it well suited to the needs of medium to large scale enterprises.



ADDERLink INFINITY 100T

A ZeroU™, high performance IP KVM transmitter. Powered by USB, retrofittable with existing infrastructure and available with DVI, VGA and DisplayPort interfaces, it is the perfect solution for environments where space is a premium.



ADDERLink INFINITY 3000

A high performance IP KVM receiver that allows users to seamlessly take control of unlimited servers whether they are in a physical or virtual environment.



ADDERLink INFINITY 4000

A high performance dual-head IP KVM matrix solution with support for 5K video resolutions, multigigabit Ethernet connectivity and digital DisplayPort™ audio.

ADDERLink INFINITY Comparison Chart

Part	Video	Connectors	USB	Audio	Network	Extra Features
Transmitters						
ALIF100T	1 @ up to 1920 x 1200	DVI, DP or VGA	USB1.1 Type A	USB audio device (mic & speaker)	1 x RJ45	-
ALIF1002T	1 @ up to 1920 x 1200	DVI	USB2.0 Type B	Bi-Directional Analog 2 x 3.5mm audio jack	1 x RJ45, 1 x SFP	RS232
ALIF2020T	2 @ up to 1920 x 1200	DVI	USB2.0 Type B	Bi-Directional Analog 2 x 3.5mm audio jack	1 x RJ45, 1 x SFP	RS232
ALIF2002T	2 @ up to 1920 x 1200/ 1 @ up to 2560 x 1600	DVI (Dual-link)	USB2.0 Type B	Bi-Directional Analog 2 x 3.5mm audio jack	1 x RJ45, 1 x SFP	RS232
ALIF2112T	2 @ up to 1920 x 1200/ 1 @ up to 2560 x 1600	DVI (Dual-link)	USB2.0 Type B	Bi-Directional Analog 2 x 3.5mm audio jack	1 x RJ45, 1 x SFP	RS232 + RealVNC Gateway
ALIF4021T	2 @ up to 5120 x 2880	DP	USB2.0 Type B	DisplayPort™ digital audio plus bi-directional analog via 2 x 3.5mm audio jack	2 x RJ45, 2 x SFP+	RS232
Receivers						
ALIF1002R	1 @ up to 1920 x 1200	DVI	4-Port USB2.0 hub	Bi-Directional Analog 2 x 3.5mm audio jack	1 x RJ45, 1 x SFP	RS232
ALIF2000R	2 @ up to 1920 x 1200/ 1 @ up to 2560 x 1600	DVI (Dual-link)	4-Port USB2.0 hub	Bi-Directional Analog 2 x 3.5mm audio jack	1 x RJ45, 1 x SFP	RS232
ALIF2020R	2 @ up to 1920 x 1200	DVI	4-Port USB2.0 hub	Bi-Directional Analog 2 x 3.5mm audio jack	1 x RJ45, 1 x SFP	RS232
ALIF3000R	2 @ up to 1920 x 1200/ 1 @ up to 2560 x 1600	DP	4-Port USB2.0 hub	Bi-Directional Analog 2 x 3.5mm audio jack	1 x RJ45, 2 x SFP	Virtual Machine Access
ALIF4021R	2 @ up to 5120 x 2880	DP	5-Port USB2.0 hub	DisplayPort™ digital audio plus bi-directional analog via 2 x 3.5mm audio jack	2 x RJ45, 2 x SFP+	RS232 (via USB Converter)

Access Your Virtualized World

With the introduction of the ADDERLink INFINITY 3000 (ALIF3000), IT administrators can give users real-time access to unlimited virtual and physical machines, directly from their own individual user workstation.

The ALIF3000 is ideally suited to meet the demand for instant switching between unlimited physical and virtual machines, driven by the rise in hybrid IT environments. Using standard VDI protocols, the ALIF3000 delivers real-time access to legacy machines and virtualized applications from a single human-machine interface (HMI) - improving flexibility, desktop ergonomics and efficiency.

The ALIF3000 delivers KVM and VM access without requiring additional hardware or compromise on KVM functionality. By incorporating VDI protocols into the receiver, the ALIF3000 allows all operators to access all machines in a more efficient way. Instead of adding a new transmitter every time a user needs access to a new virtual session, an administrator can easily configure the management system to enable permissions.

The ALIF3000 has been designed to seamlessly and securely integrate VM access into an existing ADDERLink INFINITY network without disruption, downtime or costly replacement fees. By utilizing the trusted ADDERLink INFINITY Manager (AIM), IT administrators can clearly define user access rights to ensure that target PC's and virtual sessions can only be accessed by permitted users - providing peace of mind and ensuring security is optimized.

The Rise of Virtual Machine Access

Organizations are increasingly embracing a hybrid approach to their IT deployment. According to Forrester (2019), 88% of businesses are now combining physical and virtual IT environments.¹

In typical KVM environments, this growth is being driven by popular software providers who are now delivering their platforms in both on-premise and virtualized formats.

¹ Mainframe In The Age Of Cloud, AI, and Blockchain report (Forrester, 2019)

KVM and Virtual Machine Access

As organizations continue to adopt hybrid IT strategies, administrators are looking for ways to give users real-time access to both physical and virtual machines from a single HMI.

Typically, companies have used KVM to control their physical machines and a thin client to access their virtualized servers but this requires additional hardware which can be costly and detrimental to user efficiency and workstation ergonomics.

The ALIF3000 is ideal for IT administrators as they look to streamline their hardware deployment, improve HMI ergonomics and provide their users with instant switching between physical and virtual machines.

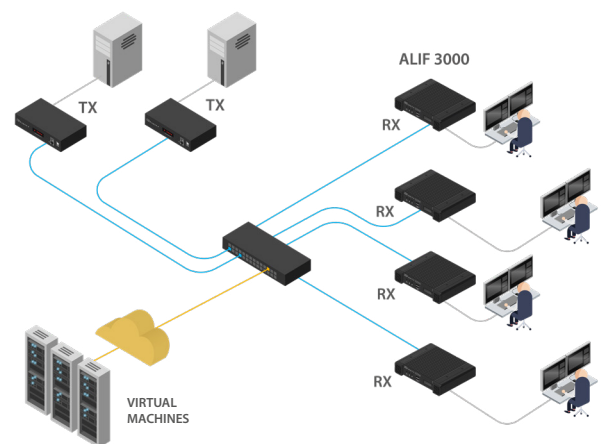

Industry Focus

Virtualization is becoming integral to operational efficiency and productivity in a wide range of typical KVM industries, including: VFX, Transport, Industrial, Utilities and more.

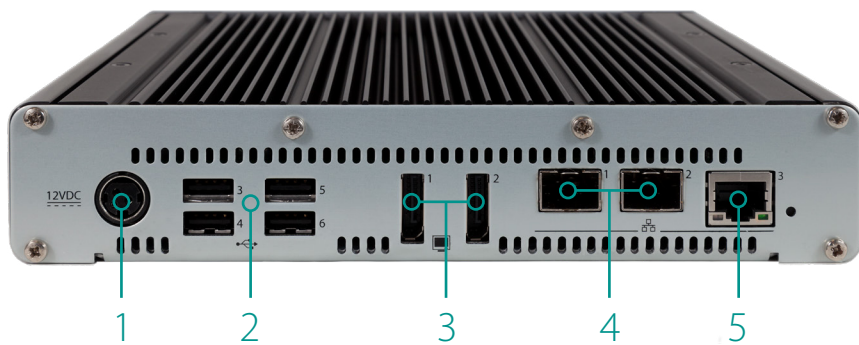

- 1 Power
- 2 USB 2.0
- 3 Video
- 4 Dual 1Gb SFP Ports
- 5 Network Port

Performance

Built on Intel®'s successful X-86 architecture, the ALIF3000 is a robust and resilient solution designed for use in the most challenging scenarios.

Security

The ALIF3000 is a closed and hardened KVM system with virtual machine access. Unauthorized software cannot be loaded onto the units without administrator approval.

The ALIF3000 Combines:

- Single or dual-head
- Supports resolutions up to 2560x1600
- Unlimited access to virtual and physical machines
- Pixel-perfect image quality over 1Gb ethernet links
- USB 2.0 with fast switching
- Backwards compatibility with existing ADDERLink INFINITY range

Choice and Compatibility

The ALIF3000 can be added to an existing ADDERLink INFINITY matrix to deliver real-time KVM and virtual machine access - with the security, reliability and flexibility benefits of traditional IP KVM solutions.

About Adder

Global Leader

Established in 1984 by Adrian Dickens, an Engineering graduate from the prestigious University of Cambridge, Adder has become a global leader in the design and manufacture of connectivity and high performance IP KVM solutions. Adder's established and respected heritage in the market has led to the brand being trusted to meet their KVM requirements by the world's leading organizations.



Made in the UK

Adder's range of solutions are designed and manufactured at its ISO-certified development center in Cambridge, UK and shipped worldwide. Years of investment in research, development and manufacturing have ensured that Adder's products are justifiably renowned for their technical excellence, reliable performance and outstanding quality.

Adder Solutions Grow Alongside Business Needs

Adder understands that businesses change and evolve over time and that technology must provide the flexibility to grow in sync with the wider organization. Adder's matrix solutions are all designed with flexibility in mind – allowing endpoints to be added as the business grows - avoiding the need to over commit budget at the point of system design or implementation.



A Global Focus

In order to support its global customer base, Adder has a number of established offices around the world. Through this network of global offices and a comprehensive partner program, Adder is able to deliver dedicated around the clock sales support and a complete 24/7 Professional Services offering.

Global Headquarters

Tel: +44 (0)1954 780044 | Fax: +44 (0)1954 780081
Email: sales@adder.com

Americas

Tel: +1 888 932 3337 | Fax: +1 888 275 1117
Email: usasales@adder.com

Asia Pacific

Tel: +65 6288 5767 | Fax: +65 6284 1150
Email: asiasales@adder.com

All company names and trademarks™ or registered trademarks™ are acknowledged and are the property of their respective holders. Use of them does imply any affiliation with or endorsement by them. ADDER Technology Ltd. | ADDER_BR020_EN_v9_FINAL_AP

ADDER®
THE IP KVM PEOPLE